

User Manual

Color video door phone CDV-70KR3



- Thank you for purchasing COMMAX products.
- Please carefully read this User's Guide (in particular, precautions for safety) before using a product and follow instructions to use a product exactly.
- The company is not responsible for any safety accidents caused by abnormal operation of the product.



Greetings

- Thank you for choosing COMMAX.
- Please read this manual carefully before you use the product.











Table of contents

Greetings	1
Table of Contents	1
1. Warnings and caution	2
2. Product Overview.....	4
3. How to use	5
4. Settings	7
5. Installation.....	9
6. Wiring	10
7. Package Contents.....	12
8. Caution in use	13
9. Miscellaneous	13
10. Specification.....	13













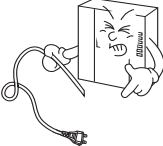



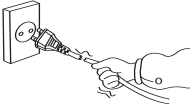





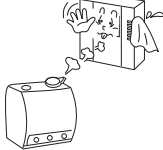

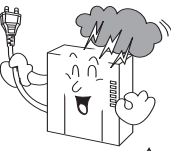

1. Warnings and caution

Please follow the things described below in order to prevent any danger or property damage.

 <p>Warning It may cause a serious damage or injury if violated.</p>  <p>Caution It may cause a minor damage or injury if violated.</p>	<ul style="list-style-type: none">  Prohibition.  No disassembly  No touch  Must follow strictly.  Shows plugging out the power cord without an exception  Shows the warning and caution for an electric shock.  Shows the warning and caution for a fire.
---	--

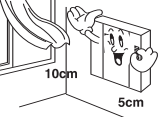
Warning

Power & Installation	<p>Please don't use several products at the same time on one power socket. · It may cause a fire due to an abnormal overheating.</p>  <p> </p>	<p>Please don't bend the power cable excessively or it may cause an electric shock. · fire when using a damaged power cable.</p>  <p>  </p>	<p>Please don't handle the power cable with a wet hand. · It may cause an electric shock.</p>  <p> </p>	<p>Please plug out the power cable from the socket when not using it for a long period of time. · It may shorten the product lifespan or cause a fire.</p>  <p> </p>
	<p>Please don't install the product in the place where there is much oil, smoke or humidity. · It may cause an electric shock or fire.</p>  <p>  </p>	<p>Please don't install the product with the lightning and thunder. · It may cause an electric shock or fire.</p>  <p>  </p>	<p>Please don't use and connect this product with other products with different rated voltage · It may cause a disorder or fire.</p>  <p> </p>	<p>When installing the product that generates heat, please install the product away from the wall (10cm) for the ventilation. · It may cause a fire due to the increased internal temperature.</p>  <p> </p>

! Warning

Cleaning & Use

Please don't disassemble, repair or rebuild this product arbitrarily (please contact the service center if a repair is needed).

- It may cause an electric shock or fire.





No disassembly



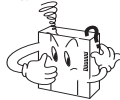

If an abnormal sound, burning smell or smoke is coming out of the product, please plug out the power cable and contact a service center.

- It may cause an electric shock or fire.



Please don't insert any metallic or burnable materials into the ventilation hole.

- It may cause an electric shock or fire.

Please use only the designated batteries for the products of using DC power.

- It may cause an electric shock or fire.





! Caution

Power & Installation

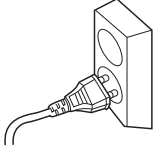

Please plug the power cable firmly into the inner end

- It may cause a fire.



Please hold the plug tightly when unplugging the power cable (a part of the copper wire may be disconnected if the grabbing is only made on the cord when pulling out the cable).

- It may cause an electric shock or fire



When connecting the power cables after cutting the cable, please install the product with power off

- It may cause an electric shock or fire



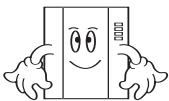

When installing the product, please fix it firmly while using the wall-mounting unit and screws.

- It may cause an injury from the falling object.



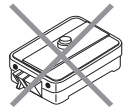

Please be careful when using an AC circuit breaker since there is a possibility of an electric shock.

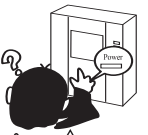

Please check the use voltage and current for the DC-only products and use the appropriate rectifier.

- It may cause a fire.

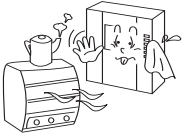

Please avoid direct rays of the sun or heating devices at a time of installation.

- It may cause a fire.



Please don't install the product on an unstable place or small support board.

- It may cause an injury if it falls down while in use.



Cleaning & Use

When cleaning the product, please rub it with a soft and dry cloth after plugging out the power cable. (Please don't use any chemical products such as wax, benzene, alcohol or cleanser.)

Please don't drop the product on the ground and don't apply a shock.

- It may cause a failure.

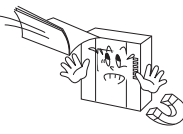
Please use the designated connection cable within the maximum calling distance designated for the product

- It may reduce the product performance.





2. Product Overview

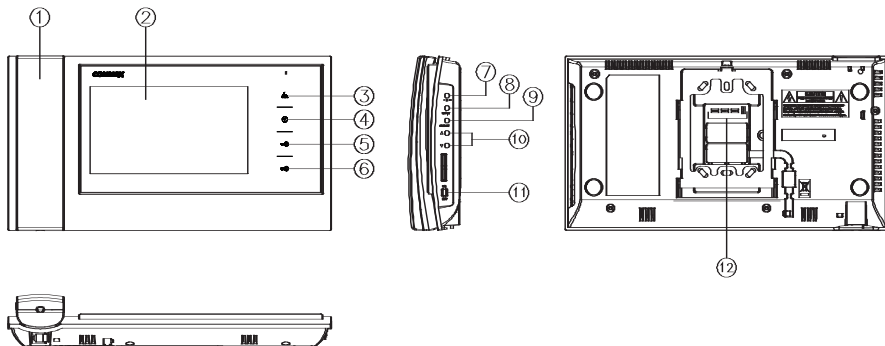

No.	Description	No.	Description
1	HANDSET	9	SELECT BUTTON
2	MONITOR	10	UP BUTTON(Δ) / DOWN BUTTON(▽)
3	MONITOR BUTTON		
4	INTERPHONE BUTTON	11	POWER SWITCH
5	DOOR RELEASE BUTTON	12	EXTERNAL CONNECTION TERMINAL
6	2ND DOOR RELEASE BUTTON		
7	RINGTONES VOLUME		
8	MENU BUTTON		

① HANDSET

② MONITOR: The image of visitor is shown.

③ MONITOR BUTTON(ENTRANCE) : Check the situation of entrance.

④ INTERPHONE BUTTON : Call the interphone.

⑤ DOOR RELEASE BUTTON : Release the door for visitor.

⑥ 2ND DOOR RELEASE BUTTON

⑦ RINGTONES VOLUME : Adjust the ringtones volume.

⑧ MENU BUTTON

To enter the menu for screen control, mute setting and product information.

⑨ SELECT(SELECT BUTTON): Press to select an item from the menu.

⑩ UP BUTTON : Move from the menu items to up and right.

DOWN BUTTON : Move from the menu items to down and left.

⑪ POWER SWITCH : Turn your device on and off.

⑫ EXTERNAL CONNECTION TERMINAL : For product update and connection between lobby and interphone.



3. How to use

Call from a visitor

- ① When the visitor calls from the entrance(door camera), the calling sound rings and the image of the visitor is shown on the screen.
- ② By picking up the handset, you can talk with the visitor. If you press door release button, door will be released.(Door release works only while talking and it is possible only when the door camera is interlocked with door release function.)
- ③ 3-way communication is possible when another user picks up the handset of extended interphone, when you are talking with door camera on video door phone. (Entrance-Household-Interphone simultaneous communication mode)
- ④ If you put down the phone, talking is finished and turns to stand-by mode.

Call with additional interphone

(1) Call from interphone to video door phone(household)

- ① The calling sound rings when there is a call from interphone.
- ② By picking up the handset, you can talk with the person using interphone.
- ③ Image of visitor is shown on the screen and 3-way communication is possible between household, interphone and door camera when visitor calls from door camera, while household is talking with interphone.

(2) Call from video door phone to interphone

- ① After picking up handset of video door phone, and then press INTERPHONE BUTTON in order to call the interphone.(Interphone is called only while the interphone button on household is being pressed.)
- ② When you receive the call from interphone, enjoy the call.

Monitoring : function to see the image of visitor in the entrance.

(On stand-by mode - status of putting handset down) Operation

- By pressing the Monitor button repeatedly, the monitor will work as following in order.
Camera 1 → Camera 2 → OFF → Camera 1 →

(One talking mode - status of putting handset up) Operation

- By pressing the Monitor button repeatedly, the monitor will work as following in order.
Camera 1 → Camera 2 → Camera 1 → Camera 2 →

Adjust the volume

When you press volume key repeatedly on stand-by status, you can hear each level of ringtone and volume level will be pop up on the screen. Ringtone of additional interphone is same with volume level of video door phone.

* **Caution**

When the call volume switch is clicked for call volume adjustment, call sound will be heard from the handset 1 time for a user to check the sound.

Please make sure that handset is in position, when the call volume function is being used.

- When call volume control switch is clicked, it will operate in order as follows.
- (Stand by mode - In position)
- CHIME-VOL0 → CHIME-VOL1 → CHIME-VOL2 → CHIME-VOL3 → CHIME-VOL0

Door Release Function

If you press the 'door release' button (Key shaped button), the monitoring door camera will make a sound and release the door.

(the door release function is only enabled while in a monitoring mode)

* The same rule applies to COMMAX interphone series.

If you press the '2nd Door Release' button while in a monitoring mode, the 2nd door is released.

* '2nd Door Release' only enabled for the 2nd door release function on camera 1 (only applicable for DRC-40KR2 model or other camera models with a built-in 2nd door release function).

'2nd Door Release' button is for the 2nd door release function on camera 1 only and not for the camera 2.



4. Settings

You can adjust DOOR VIDEO SET, UTILITY and check INFORMATION(model name &version) with (UP)△, / (DOWN)▽ button after pressing Menu button on the right of the product in video talk mode or stand-by mode.

- Products settings need the following 4 buttons on the right of product.
- * Start Menu / Exit : MENU button * Select and in-put : SELECT button
- * Move up / Move right : △(UP button) * Move down / Move left : ▽(DOWN button)

4-1. Screen setting (Brightness/Contrast/Color adjustment function)

Press the Menu button and access to DOOR VIDEO SET and enter the setting menu by pressing SELECT button.

- (1) BRIGHTNESS : Adjusting Brightness of Screen
- (2) CONTRAST : Adjusting Contrast of Screen
- (3) COLOR : Adjusting Color of Screen

※ How to adjust

- ① Move to Menu you want to adjust with △/▽ button on the list of DOOR VIDEO SET
- ② Press SELECT button to choose an icon.
- ③ Adjust the set value with △/▽ button
- ④ To complete the set, press SELECT button.

- (4) RESET : Initializing

※ How to reset.

- ① Move to RESET menu in DOOR VIDEO SET menu
- ② Press SELECT to enter the menu.
- ③ Select YES with △/▽ button
- ④ Press SELECT button.

- (5) EXIT : Go back to setting mode

4-2. UTILITY(additional function)

Press the Menu button and access to Utility SET and enter the menu by pressing SELECT button.

- (1) CHIME-BELL VOLUME : setting volume sound .
 - ① Move to CHIME-BELL VOLUME icon with △/▽ button in UTILITY Menu.
 - ② Press SELECT to enter the menu.
 - ③ Select the volume sound or not with △/▽ button.

- ④ To complete the set, press SELECT button.
- (2) SCREEN MODE : to set for screen ratio
 - ① ZOOM : Zoon in(expansion) image maintaining actual ratio(4:3) is shown. (full of the screen)
 - ② 4:3 : Image of 4:3 ratio without expansion is shown.(This is actual ratio for camera)
 - ③ WIDE : Full of the screen. Not actual ratio (4:3). Image is expanded according to LCD (WIDE LCD) ratio.
- * How to adjust
 - ① Access to SCREEN MODE with Δ/∇ button in UTILITY Menu
 - ② Press SELECT button to enter the menu.
 - ③ Adjust screen ratio value with Δ/∇ button.
 - ④ To complete the set, press SELECT button.
- (3) EXIT : Go back to Setting menu

4-3. INFORMATION (The function to check Model name & Version)

In order to check the product information, press menu button and move to INFORMATION menu with Δ/∇ button.

- (1) MODEL : You can check the model name.
- (2) VERSION : You can check the model version.
- (3) VIDEO : You can check the video transmission formats(NTSC/PAL)
- (4) SOURCE :

You can check the position of camera(DOOR1 / DOOR2) which is shown on the screen for now.

4-4. EXIT(Finish setting menu)

4-5. RESET : Initializing

Keep pushing interphone and door open button for 3 seconds(Screen setting and Call volume will be initialized)

Caution

If initialization is activated, all data including screen setting will be initialized) (Screen setting and Call volume)

5. Installation

1. Installation Method of camera monitor

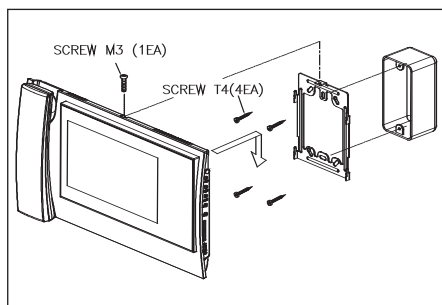

⚠ Note

- ① Avoid the range of direct sunlight
- ② Recommended height is pertinent from 1450 ~ 1500mm
- ③ Avoid the installation near magnetic activity, humid temperatures and gas

2. Installation Method of camera

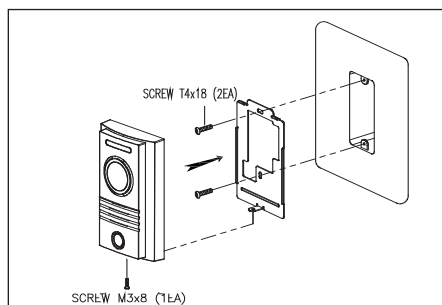

⚠ Note

- ① Do not install the camera where it is exposed to Direct sunlight
- ② Keep cleaning up its lens to capture good views.

6. Wiring

The wiring of this equipment is as follows.

Camera connector polarity

1. RED : VOICE
2. BLUE : GND
3. YELLOW : POWER(+12V)
4. WHITE : VIDEO

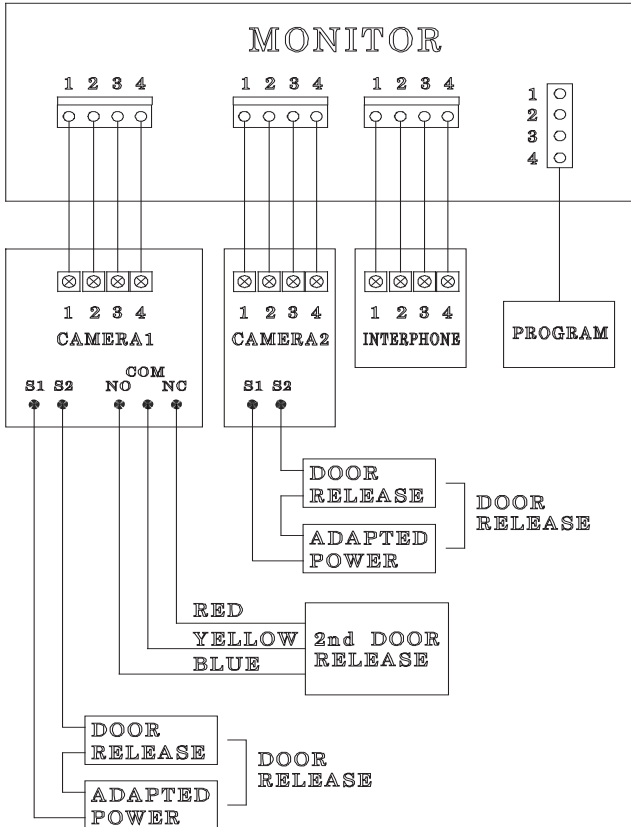

Wiring precautions

Each device should be connected by separated cables.

If you use UTP CABLE[CAT.5] for CAMERA1 and CAMERA2, 2 lines of UTP cable are required.

DOOR Camera Wiring

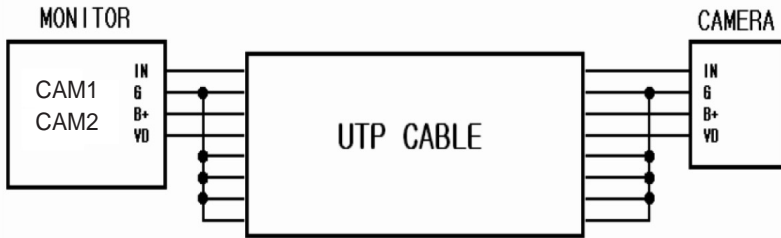

- If you use UTP CABLE[CAT.5], connect the rest 4 lines to GND after connecting 4 lines between monitor and camera.

INTERPHONE Wiring

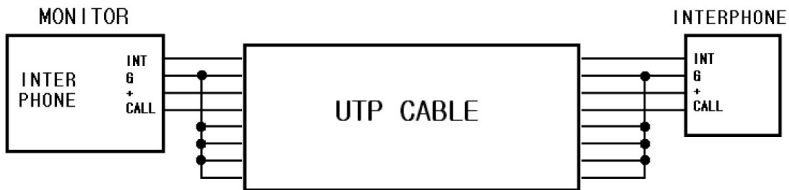

- If you use UTP CABLE[CAT.5], connect the rest 4 lines to GND after connecting 2 lines between monitor and interphone.



7. Package Contents

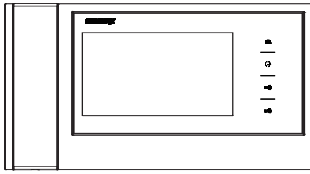

① Body of CDV-70KR3

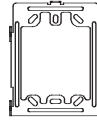

② Bracket for wall mount

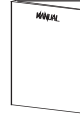

③ Manual

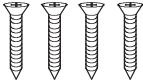

④ T4 X 18(4EA)
Screw for wall mount



⑤ M 3 X 6(1EA)
Screw for body

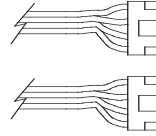

⑥ 4P Connector(2EA)

- ① Monitor(CDV-70KR3)
- ② Wall bracket for monitor
- ③ User Manual
- ④ Mounting Screw (SCREW GH1T 4X18 ZnY) – 4EA
- ⑤ Monitor fixing screw (SCREW PHM 3X6 ZnY) – 1EA
- ⑥ Connector (CONN. 4PX300) – 2EA



8. Caution in use

1. Turn on the power switch.
2. Please contact your local agent for product maintenance when you have a problem in use of CDV-70KR3
3. For your safety, power switch with a safety device must be used in your building.
4. Unplug before installing or repairing the product.
5. Unplug when you connect monitor with door cameras.



9. Miscellaneous

- Please carefully read this User's Guide before calling service man
After checking the entire check list, please contact customer service center.
We will do our best to make you satisfy with our services.



10. Specification

MODEL	CDV-70KR3		
Wiring	4 wires with door camera(Polarity)		
	4 wires with interphone(Polarity)		
Rating Voltage	100-240V~, 50/60Hz (FREE VOLTAGE)		
Power consumption	Stand-by : 4.5W Maximum : 16W		
Transmission way	HAND SET		
Screen	17.78Cm(7") TFT-DIGITAL LCD		
Ringtone	Entrance : electronic chime		
	Interphone : electronic buzzer		
Screen Display	Monitoring : 30 ±5sec , Talk : 60 ±5sec		
Cable thickness &	Pie 0.5mm	0.65mm	0.8mm
Distance	28m	50m	70m
Working temperature	0 ~+40°C (32°F ~ 104°F)		
Dimension	311(W) X 168(H) X 32(50.3)(D)		

COMMAX

COMMAX Co.,Ltd.

513-11, Sangdaewon-dong, Jungwon-gu, Seongnam-si, Gyeonggi-do, Korea

Int'l Business Dept. Tel. : +82-31-7393-540~550 Fax. : +82-31-745-2133

Web site : www.commax.com

PM0770KR2010

Printed In Korea / 2014.03.104